

Follow us



HAPPINESS IS A JOURNEY

USER MANUAL

CUXPR3

SAFETY INSTRUCTIONS

To ensure your safety, please read this manual carefully before riding and make sure you are always following the requirements below:

- 1 Fully understand the information in this manual, include but not limited to the relevant instruction, precautions and warnings.
- 2 Fully understand the operation and contingency measures of CUX PRO smart electric vehicle.
- 3 Be Fully aware of warning labels of CUX PRO smart electric vehicle.
- 4 Don't disassemble vehicle or any parts, if need replacement, please contact local dealer.
- 5 Please keep this manual carefully.



All parameters of this vehicle have been permanently set according to the national standard before leaving factory. The company is not responsible, if the original electrical or circuit has changed and caused excess, such as increase the speed.

USER INSTRUCTIONS

To ensure the safety of you and others, please make sure to observe the following matters:

- 1 Don't lend your vehicle to someone who can't operate it in order to prevent any hurts.
- 2 Please comply with local laws and regulations to drive on the road.
- 3 Do not ride after you take medications which may affect your riding ability, drink alcohol, or when you are unwell.

USER INSTRUCTIONS

- 4** Observe traffic regulations and traffic signs, according to the provisions of laws and regulations to carry man and cargo. Confirm the surrounding road conditions and vehicle condition any time, so as to actively avoid danger.
- 5** In rainy and snowy weather, braking distance will be extended, please slow down, Avoid travelling in bad weather such as storms and typhoons.
- 6** Wear safety equipment, such as helmet, and appropriate protective clothing if necessary, such as gloves and mask.
- 7** To ensure the safety of you and others, please avoid using the high beam under good lighting conditions. Continuous use of the high beam will cause visual obstacles to the opposite vehicles and pedestrians and affect the safe driving
- 8** Please turn off the power and remove the key immediately after use. Do not allow children to play, so as to avoid loss to your family and property.
- 9** Perform a basic check each time before riding, and regularly go to VMOTO Service Center for maintenance.
- 10** Check before riding. If there is any abnormality, please timely carry out maintenance or seek professional maintenance.
 - a.** Check the status of power circuit, lighting circuit, etc.
 - b.** Check whether the front and rear brakes work normally.
 - c.** Check fixing of handlebars、 front and rear wheels
 - d.** Check tire pressure.



All pictures in this manual are for reference only, please refer to the actual product. The pictures in the manual are based on the VMOTO electric vehicle CUX PRO, please refer to the bikes for details.

The actual product function may differ from the manual content due to technical upgrades, firmware updates or other changes. For the latest function introduction and safe use guide information, please download VMOTO APP, and refer to the embedded electronic manual: or visit the official website of VMOTO: www.vmoto.com

QUICK START

- 01 -

Check Accessories Items



x 2

Remote controls



x 1

Rear view mirrors



x 1

User manual



x 2

Keys



x 1

Spanner for mirrors



x 1

Charger

QUICK START

-02-

Install Battery Pack

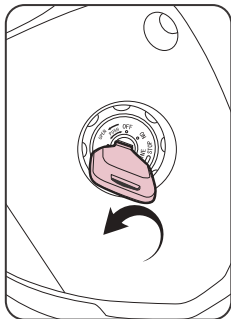

1 Open the saddle and battery box

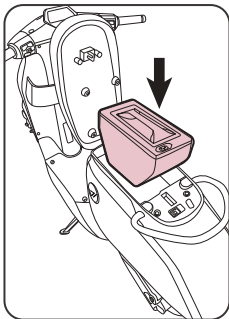

2 Put battery pack in

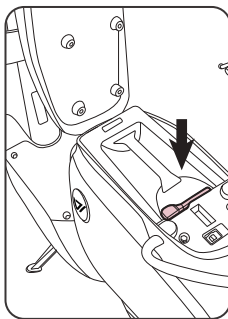

3 Connect power

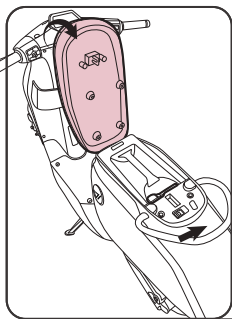

4 Turn on kill switch, put down saddle.

QUICK START

- 03 - Quick Start

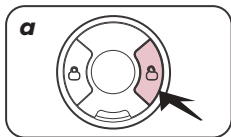

1 Press “unlock” on remote control

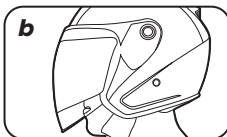

2 Put on helmet

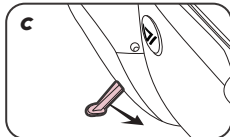

3 Get on CUX PRO, kick side stand out

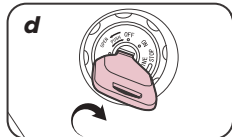

4 Get on CUX PRO, kick side stand out

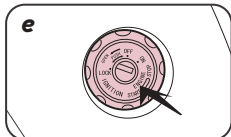

5 Press “Start”, power on

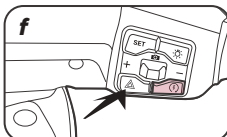

6 Press “parking” button

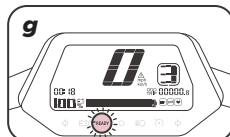

7 Remove parking condition, “ready” symbol on

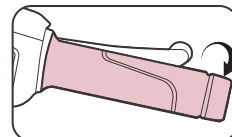

8 Turn throttle, vehicle move

- 04 -

Download APP

**CUX PRO has GPRS function, can connect with your smart phone.
By APP,you can use smart phone to manage and query your CUX PRO.**

Only iOS and Android are currently available now, please confirm your smart phone operating system in advance.

iOS system:APP only supports Apple iOS 9.0 system and above.

Android system: APP only supports Android 4.4 system and above.

Download and install the VMOTO APP by QR code in this manual .



VMOTO APP

From the date of purchase of the vehicle, you will automatically receive a free two-year central control SIM card data in order to use the VMOTO electric APP function. Please be sure to complete the next year's data recharge before the end of the two-year free period. If the recharge is not overdue, the operator will automatically close the recharge interface, the flow recharge function cannot be restored, and the VMOTO electric vehicle APP cannot be used normally.

CONTENTS

DESCRIPTION OF COMPONENTS AND PARTS	08
OPERATION GUIDE	10
RIDING GUIDE	16
BATTERY USE INSTRUCTION	19
APP INSTRUCTION	22
MAINTENANCE	24
COMMON PROBLEMS AND TROUBLESHOOTING METHODS	26
CHECK LIST	31

DESCRIPTION OF COMPONENTS AND PARTS

a. Schematic Diagram Of Components And Parts

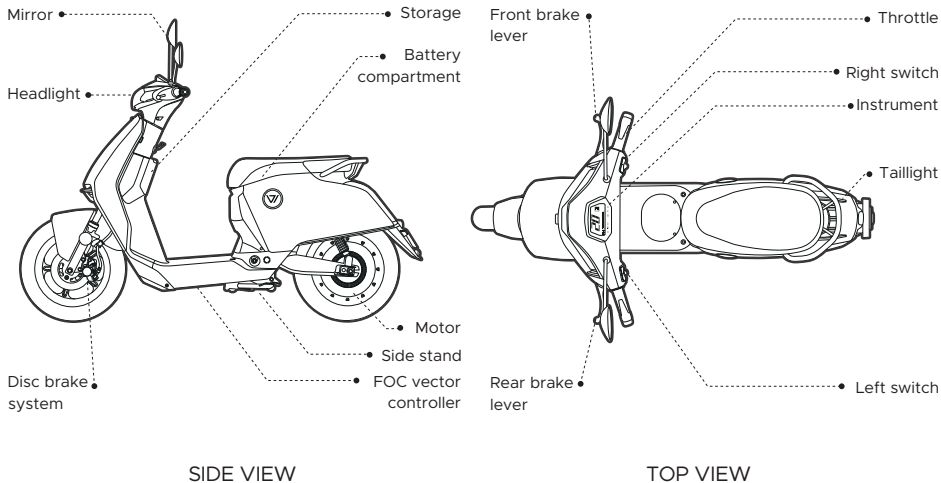

DESCRIPTION OF COMPONENTS AND PARTS

b. Schematic Diagram Of The Speedometer

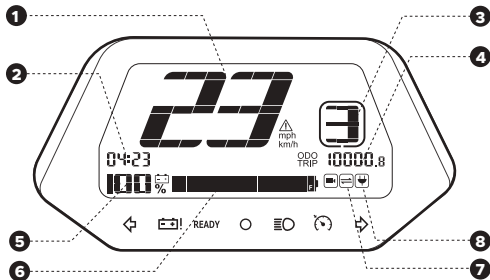

☰○ High beam indicator light

High beam on

↔ Turning indicator light

Turning light on and flickering

⚡ Battery error indicator light

Battery error

Ⓢ Cruise indicator light

Cruise indicator light on when cruising

⚠ Errors indication

🔋 Charging

📶 ECO Mode

📶 NORMAL Mode

📶 SPORT Mode

① Speed indication

Show current speed

② Time/Error code

Indicate current time, when "Error" symbol on, Show error code

③ Mode

Indicate real-time riding mode

④ Total range/Current trip range

Indicate total range/current trip range

⑤ SOC in %

Indicate real-time battery capacity

⑥ SOC in bars

Indicate real-time battery capacity

⑦ Data connect condition indication

Data connect condition symbol hint

⑧ Charge condition indication

Charge condition symbol hint

OPERATION GUIDE

a. Left Switch

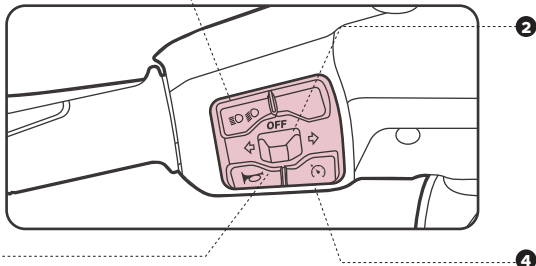
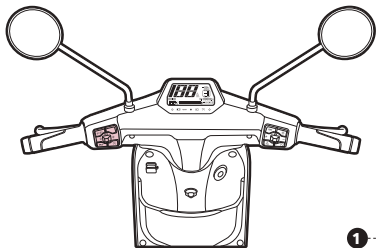

1 Horn button

Press, horn on; release, horn off.

2 Turning light button

Move to left, left turning lights on;
Move to right, right turning lights on;
Press the middle "OFF" button, turning lights off.

3 High/Low beam switch

Touch lightly to change high/low beam status.

4 Cruise button

Turn handlebar to a constant angle(speed remains constant), touch the button to get into cruise,brake or increase the angle of handlebar to remove cruise.

OPERATION GUIDE

b. Right Switch

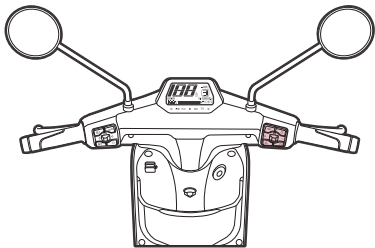

1

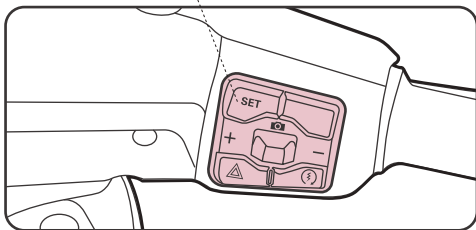

1 Set button

Instrument indication mode change button

a. Normal mode, short press the button, switch the mileage display mode (ODO/trip), and keep the status.

b. Short mileage display mode, middle press the button, reset the short mileage (Trip) and keep the status.

c. Normal mode, long press button, switch the unit (km and mile, km/h and mph) and keep the status.

Remark:

Short press: press button for $T \leq 2s$, and release

Middle press: press button for $2s < T \leq 8s$, and release

Long press: press button for $T > 8s$, and release

OPERATION GUIDE

b. Right Switch

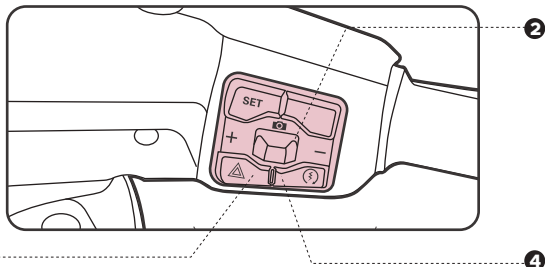
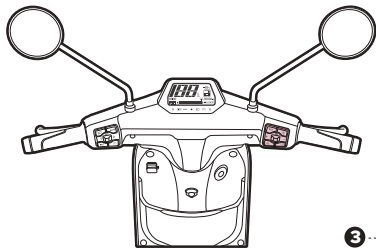

2 Gear change button

Move to left, gear increases

(when in the third gear, no change occurs with moving to left again)

Move to right, gear decreases

(when in the first gear, no change occurs with moving to right again)

3 Hazard flasher

Touch the hazard flasher button and turning lights get into the hazard flashers flashing.

4 Parking button

The "parking" is a two-gear switch. Press the button, vehicle gets into parking state.

Then press again to remove parking state and the READY light will be on at the same time.

OPERATION GUIDE

c. Unlock

After unlocking the vehicle via intelligent remote control, Press unlock, Vehicle power on, Press again, power off.

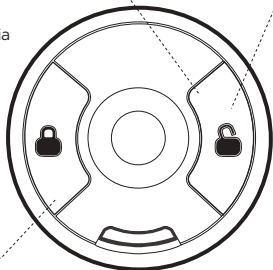

e. Lock

When vehicle in standing position, press lock, VMOTO Vehicle locked.

d. Intelligent Remote Control Operation

VMOTO intelligent remote control 2.0, Press button within effective coverage, Can lock or unlock vehicle easily, Press unlock for 3 seconds, Can open the saddle automatically

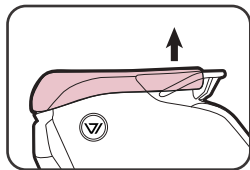

Subject to version

OPERATION GUIDE

f. Open The Storage/Battery Box

Put key in and turn key to left, Can open the storage/battery box

g. Handlebar Lock Operation

- 1 Vehicle in parking position, turn handlebar to the extreme left position, put key in handlebar lock, and turn key to left, take key out, handlebar locked.
- 2 Put key in handlebar lock and turn key to right, handlebar unlocked.

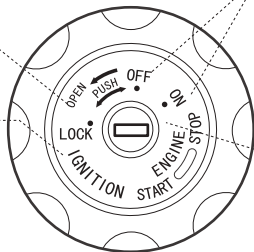
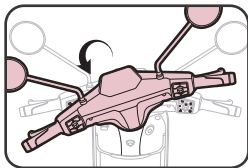

h. Start With Key

After unlocking the vehicle via intelligent remote control, Turn key to "ON", Vehicle power on, Turn key back to "OFF", power off.

i. Start Button

After unlocking the vehicle via intelligent remote control, Press start button, vehicle power on, Press again, power off.

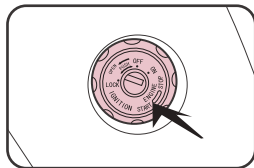
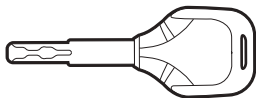

Subject to version

OPERATION GUIDE

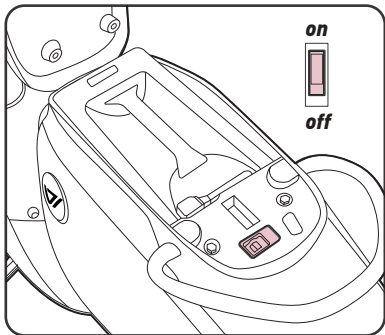

j. Circuit Protector Switch Operate

As the protection switch for the main power of CITI smart electric vehicle, the circuit protector will automatically disconnect to ensure safety when the vehicle circuit is abnormal or the current caused by short circuit exceeds the set safe value.

TIPS: In order to protect your safety, please turn off the circuit protector switch when cleaning, storing the vehicle for a long time, or removing the battery.

RIDING GUIDE

a. Check List Before Riding

Make sure to check the following items before riding a CUX PRO smart electric vehicle, which will guarantee your safety on the road.

- 1 Whether the handlebar is stable and flexible when turning.
- 2 Whether the switches on the right and left handlebars can work correct.
- 3 Whether the throttle working properly.
- 4 Make sure the tyre pressure is ok. The suggested tire pressure is 175Kpa for front wheel, 175Kpa for rear wheel.
- 5 Check tire surface, make sure no cracks, damage, and foreign matter puncture or attachment.
- 6 Whether the tread depth is sufficient. If the tire is worn to the black shadow mark in the picture, it needs to be replaced.
- 7 Whether any error warning light on the display when power on.
- 8 Whether the battery capacity is sufficient for your trip.
- 9 Whether all lights working properly.
- 10 Whether the horn working properly.
- 11 Whether the mirrors are clean. Adjust them to the proper angle.
- 12 Whether the brake oil is sufficient, whether the brake lever and brake system working properly.

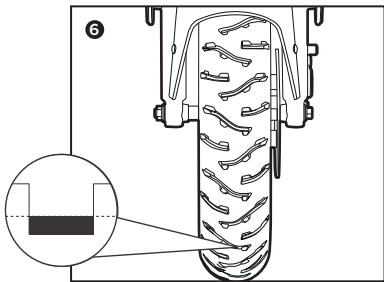

In case any questions or unusual, please contact after sales service or dealer.

RIDING GUIDE

b. Start The Vehicle

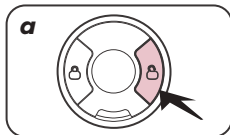

1 Press "unlock" on remote control

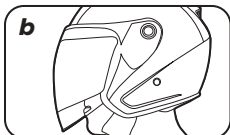

2 Put on helmet

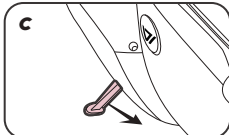

3 Riding CUX PRO, kick out side stand

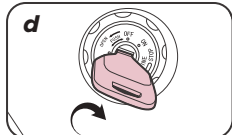

4 Put key in and turn to "ON" gear

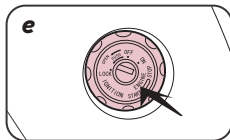

5 Press "start" button, power on

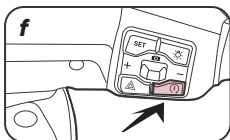

6 Press "Parking"

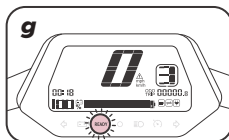

7 Remove parking condition, "READY" light on

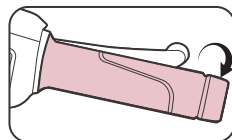

8 Turn throttle, vehicle move

TIPS: Before riding, making sure side stand is kicked out, turn handlebar to make sure the handlebar lock is unlocked. Power off will take place after pressing "PARKING" or putting side stand, so DON'T press "PARKING" or put side stand during riding, in case any danger due to power off. Vehicle must power on in steady standing position. In case any unusual situation, please glide or push vehicle to safe area, don't try to restart vehicle when riding in the driveway, in case any danger.

RIDING GUIDE

c. Riding Precautions

- ➊ Speed up slowly when starting, in order to avoid excessive starting current and increased energy consumption caused by instantaneous sudden acceleration.
- ➋ To ensure safety, it is necessary to keep constant speed during riding, reduce frequent start-up, braking, instantaneous acceleration and other operations which increase energy consumption.
- ➌ The maximum load weight of the vehicle is 150KG(5KG for rear shelf). Overload is strictly prohibited.
- ➍ Please press the “PARKING” button when pushing the vehicle, so as to prevent turning handlebar inadvertently, causing sudden start, and accidents occur.
- ➎ Turn off power when parking and remove the key.

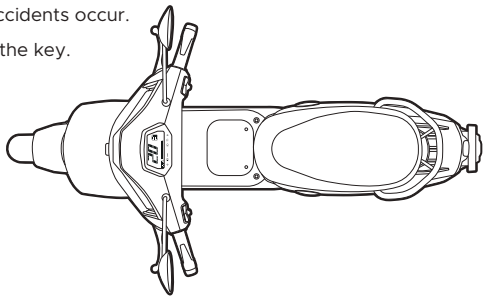

BATTERY USE INSTRUCTION

a. Charging On-board

- ➊ Insert the main charger plug into the charging port of the vehicle.
- ➋ Insert the charger's AC power plug into the socket, and the battery starts charging when the charger indicator turns red.
- ➌ The battery is fully charged if the charger indicator turns from red to green

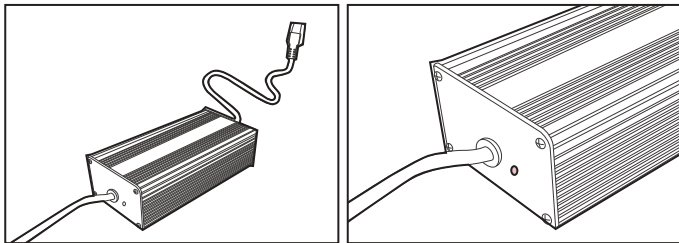

Battery level display

Charging: red light is on continuously

Full: green light on continuously

Fault: red and green light flash alternately

Battery use instruction

b. External Charging

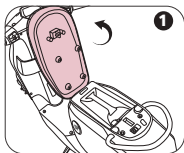

1 Open battery compartment

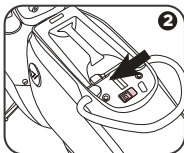

2 Turn off the kill switch

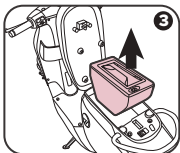

3 Take out battery pack

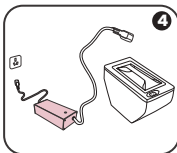

4 Connect the main plug of the charger with the battery pack

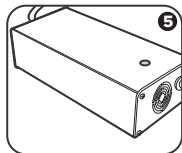

5 Connect the AC plug of the charger with power Indicator light is red when charging, light will turn green when fully charged

- TIPS:**
- Keep away from water, prevent battery pack from water spray, water immersion;
 - Charging temperature: 10 - 30°C, discharging temperature: 0 - 40°C;
 - Charging after using, in case long time no use the vehicle, must take out the battery pack;
 - Forbidden to connect battery pack input and output;
 - Don't charge or store the vehicle in residential buildings, keep away from combustible when charging.
 - Forbidden strong impact and press on battery pack;
 - Must use appointed charger, forbidden to use any other charger to charge battery pack;
 - Before delivery, battery pack has already passed strict check, forbidden to open it.

BATTERY USE INSTRUCTION

c. Storage, Maintenance And Transport

- ① When battery pack needs to be stored for a long time, please charge battery pack to the half-saturated status (charge battery pack for 3 hours with charger after the battery capacity is 0%), disconnect battery with the vehicle, prevent battery from over discharge, store battery pack in dry and ventilated place, at least charge 2 hours each 3 months.
- ② Battery pack and charger should be stored in clean, dry, ventilated place, avoid connect with corrosive substances, keep away from power source, fire source and heat source.
- ③ Battery pack storage conditions: ambient temperature 25 ± 3 °C, ambient humidity $\leq 65\%RH$.

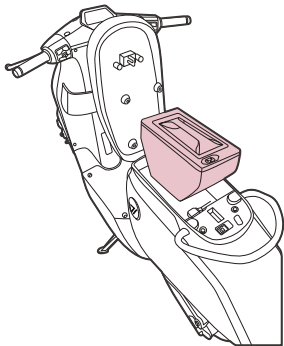

APP INSTRUCTION

CUX PRO smart electric vehicle has GPRS communication, GPS positioning and other functions, and can be connected with your smart phone. Through the VMOTO Electric Vehicle APP, you can use your smart phone to manage and query your vehicle.

*Some functions require the use of wireless networks and positioning functions, please be aware.

The current mainstream mobile phone system versions are iOS and Android operating systems, please confirm the operating system specifications of the smart phone before installation.

Main functions of VMOTO Electric Vehicle APP (Available subject to different countries)

- ① Vehicle condition diagnosis: when the vehicle is started, a one-key physical examination, real-time understanding of vehicle health status;
- ② Multiple anti-theft: When the vehicle is illegally displaced, the vehicle body will issue an alarm, and the APP will notify the user as soon as possible and track the vehicle location in real time;
- ③ Data recording: Users can learn about vehicle information, remaining power, mileage, riding trajectory and other information through the APP;
- ④ Riding appointments with riders: Through the APP, users can start mobile social interaction, realize communication between people in a new way, and enjoy the fun of online and offline riding.

APP INSTRUCTION

CUX PRO smart electric vehicle has GPRS communications, GPS locate and other functions which can be connect to your smart phone. You can manage your vehicle, query and do other operations by VMOTO APP



Download APP



Bind APP

PASTE
BARCODE

Only iOS and Android are currently available now, please confirm your smart phone operating system in advance.

iOS system:APP only supports Apple iOS 9.0 system and above.

Android system: APP only supports Android 4.4 system and above.

The functions of VMOTO Electric Vehicle APP may vary with version updates, function upgrades and different vehicle types. Please refer to the actual content of the latest version.

MAINTENANCE

Regular maintenance can improve the service life and driving safety of CUX PRO smart electric vehicle. We suggest you follow the following advice to take care of your vehicle.

a. Regular Overhaul And Maintenance

We recommend that after the initial inspection and maintenance of the new vehicle at the VMOTO Authorized Service Center 1,000 km or 3 months after the purchase of the new vehicle (based on the first arrival parameter). It is recommend that you do it every 3,000KM or 6 months (based on the first arrival parameter) for regular inspection and maintenance. VMOTO Authorized Service Center will provide maintenance services for your vehicle (maintenance services may involve fees, please refer to the service center staff or official customer service staff).

TIPS:

The maintenance provided by VMOTO Authorized Service Center is free of charge, which can be did by yourself or at a regular electric vehicle repair shop

b. Daily Cleaning And Maintenance

- **Cleaning:** Please use clean water, neutral detergent, soft cloth and sponge to clean the surface of the vehicle; Do not use metal brush, sandpaper, etc. to wipe the body, so as not to scratch the body and parts. On the surface. After cleaning, wipe the vehicle dry with a soft dry cloth.
- **Storage:** Please park the vehicle in a dry and cool room to reduce sun exposure and rain, in order to avoid corrosion of parts and shorten the service life.

MAINTENANCE

c. Warning

- 1 Please switch off the circuit protector switch before cleaning.
- 2 Do not use strong pressure water to wash it directly, in order to prevent internal electrical components and lines from intruding or soaking water and causing vehicle mechanical failures or other hidden dangers of accidents.
- 3 In case don't use for long time, please turn off circuit protector switch and disconnect the battery from vehicle; prevent over discharging, please recharge the battery 2 hours each 3 months.
- 4 After long-term storage, please fully charge it before use.

COMMON PROBLEMS AND TROUBLESHOOTING METHODS

α. FAQ & Troubleshooting

Error	Causes	Solutions
The vehicle has no electricity, and the start button does not shine	<ol style="list-style-type: none">1. Battery is poorly connected2. Circuit protector switch is not turned on	<ol style="list-style-type: none">1. Connect the power cable appropriately2. Turn on the circuit protector switch
Power on, turning accelerator, motor not run	<ol style="list-style-type: none">1. Low battery power2. Side stand is on3. At parking mode4. Brake lever does not reach the right position5. Accelerator error6. The controller plug is loose7. Controller error	<ol style="list-style-type: none">1. Charge the battery2. Kick the side stand out3. Press parking button4. Place the brake lever at the right position5. Change accelerator6. Re-plug controller7. Change controller
Speed is too slow or mileage is too short	<ol style="list-style-type: none">1. Low battery power2. Flat Tyre3. Heavily overloaded4. Brake pads need to be replaced5. Battery aging or normal scrap	<ol style="list-style-type: none">1. Charge the battery2. Pump up the tyre, check tyre pressure before riding3. Foster a good habit, keep an appropriate load4. Change the brake pads and check the brake system before riding5. Change the battery
Battery cannot be charged	<ol style="list-style-type: none">1. Poor contact of charger plug2. Used wrong charger3. Battery aging or normal scrap	<ol style="list-style-type: none">1. Check whether the battery plug is at right position or not2. Use VMOTO charger3. Change the battery

COMMON PROBLEMS AND TROUBLESHOOTING METHODS

Error	Causes	Solutions
Error 99 on speedometer	Controller communication error	Please contact after sales service or dealer
Error 98 on speedometer	Controller stop working(Possible over current,motor blocking, under voltage,over temperature)	Please stop riding and wait for a while then restart or contact after sales service or dealer
Error 97 on speedometer	Controller power tube error	Please contact after sales service or dealer
Error 96 on speedometer	Controller hall sensor error	Please contact after sales service or dealer
Error 95 on speedometer	Accelerator error	Please check the accelerator plug or contact after sales service or dealer
Error 94 on speedometer	Battery communication error	Please check the battery plug or contact after sales service or dealer
Error 93 on speedometer	Charging, over current error	Please stop charging and check the charger
Error 92 on speedometer	Charging, over voltage error	Please stop charging and check the charger
Error 91 on speedometer	Battery over temperature error	Please stop riding or charging and wait for a while

COMMON PROBLEMS AND TROUBLESHOOTING METHODS

Error	Causes	Solutions
Error 90 on speedometer	Battery discharging over current error	Please stop riding if keep showing and contact after sales service or dealer
Error 89 on speedometer	Battery charging low temperature error	Please move the vehicle to warm indoor place and wait for a while
Error 88 on speedometer	Battery discharging low temperature	Please move the vehicle to warm indoor place and wait for a while
Error 87 on speedometer	Network connection error	Please move the vehicle to open area and wait for a while or contact after sales service or dealer
Error 86 on speedometer	GPS connection error	Please move the vehicle to open area and wait for a while or contact after sales service or dealer

COMMON PROBLEMS AND TROUBLESHOOTING METHODS

b. Battery Troubleshooting

Status	Errors	Causes	Solutions
Before using	Battery runs out, unable to activate the vehicle	Battery no power	Please charge the battery
In Operation	In battery low power mode. Battery below 10% ,vehicle power-off	Battery runs out, low-voltage protection	Please charge the battery
In Operation	Display 88 Error code	Battery discharging low temperature	Please move the vehicle to warm indoor place and wait for a while
In Operation	Display 90 error code	Battery discharging over current error	Please stop riding if keep showing and contact after sales service or dealer
In operation	Display 91 error code	Battery over temperature error	Please stop riding or charging and wait for a while
In Operation	Display 94 error code	Battery communication error	Please check the battery plug or contact after sales service or dealer
In Operation	Display power reduce, over night or the next day.	ECU, controller and alarm components take power from battery automatically, normal phenomena.	Normal use
In Operation	Mileage different from the official announced	Official announced mileage is tested under specific circumstances and states. Affected by different road condition, weather, temperature, wind resistance, loading ect.	Any questions, please contact after sales service or dealer

COMMON PROBLEMS AND TROUBLESHOOTING METHODS

Status	Errors	Causes	Solutions
Storage	Press "Start" , no power	The battery is stored too long time, battery runs out	Please charge the battery. If it is not possible to charge, please contact after sales service or dealer
In Charge	Display 89 error code	Charging at low temperature	Please charge the battery in room temperature.
In Charge	Display 92 error code	Charging overtag	Stop charging the battery, check the charger
In Charge	The charger gets hot during charging	In the charging process, the internal current of the charger is too high, produce large amount of heat. The metal shell can effectively dissipate heat, which will lead to the high temperature of the shell	Please use normally, charge in dry and ventilated place
Battery water penetration	The battery is not working properly, unable to start the vehicle.	Vehicle in the rain, in the water, wading across deep causing battery flood.	Please stop using, contact after sales service or dealer
Battery box broken	Battery shell broken caused by clash or dorp from high place.	Battery shell broken	Please stop using, contact after sales service or dealer

CHECK LIST	1000 KM 3months	3000KM 6months	6000KM 12months	9000KM 18months	12000 KM 24months	15000 KM 30months	18000 KM 36months	21000 KM 42months	24000KM 48months	Torque (N·m)
Brake fluid	<input type="radio"/>		<input type="radio"/>							
Tire pressure and wear	<input type="radio"/>	<input type="radio"/>	<input type="radio"/>	<input type="radio"/>		<input type="radio"/>		<input type="radio"/>		"FR 175 KPa RR 175 KPa"
Front and rear lining pad wear		<input type="radio"/>	<input type="radio"/>	<input type="radio"/>		<input type="radio"/>		<input type="radio"/>		
Front and rear brake disc wear			<input type="radio"/>							
Fasten front axle nut and rear wheel bolt	<input type="radio"/>		<input type="radio"/>							59
Fasten the swingarm nut	<input type="radio"/>		<input type="radio"/>							59
The motor and the motor retainer bolt fastening nut	<input type="radio"/>		<input type="radio"/>							80
Fasten Front and rear shock bolt fastening	<input type="radio"/>		<input type="radio"/>		<input checked="" type="radio"/>		<input checked="" type="radio"/>		<input checked="" type="radio"/>	F.Upper 22/ F.Lower 32/R45
Steering column locking nut										74
Fasten front caliper bracket (coated glue thread)	<input type="radio"/>		<input type="radio"/>							26
Fasten front brake disc (coated glue thread)	<input type="radio"/>		<input type="radio"/>							42
Fasten rear caliper bracket (coated glue thread)	<input type="radio"/>		<input type="radio"/>							26
Fasten rear brake disc (coated glue thread)	<input type="radio"/>		<input type="radio"/>							42
Battery	<input type="radio"/>	<input type="radio"/>	<input type="radio"/>	<input type="radio"/>		<input type="radio"/>		<input type="radio"/>		

Note: Check the lithium battery balance by BMS reading and manual measurement.

MAINTENANCE RECORD:

Content:

Date:

MAINTENANCE RECORD:

Content:

Date:

MAINTENANCE RECORD:

Content:

Date:

MAINTENANCE RECORD:

Content:

Date:

MAINTENANCE RECORD:

Content:

Date:

MAINTENANCE RECORD:

Content:

Date:

MAINTENANCE RECORD:

Content:

Date:

MAINTENANCE RECORD:

Content:

Date:

MAINTENANCE RECORD:

Content:

Date:

MAINTENANCE RECORD:

Content:

Date: