



TLC
WANDERER

Follow us

 Vmoto Soco e-mobility

 vmotosoco

 vmotosoco

 vmotosoco Vmoto

SUPER
SOCO

USER MANUAL

SAFE INSTRUCTION

To ensure your safety, please read this manual carefully before riding and make sure you are always following the requirements below:

- 1 Fully understand the information in this manual, including but not limited to the relevant instructions, precautions and warnings
- 2 Fully understand the operation and contingency measures of TC intelligent electric vehicle
- 3 Be fully aware of warning labels of TC intelligent electric vehicle
- 4 Do not disassemble the electric vehicle and parts without permission, Please contact customer service department and dealers if you need any replacement or do further purchase.
- 5 Please keep this User Manual properly



All parameters have been permanently set according to national standards before delivery, our company is not responsible for anything change like the original electrical circuit ,wire harness and maximum speed.

USER INSTRUCTION

To ensure the safety of you and others, please make sure to observe the following matters:

- 1 Please do not lend your vehicle to someone who can not control it to avoid injury
- 2 Minors under 16 years old is not allowed to ride our vehicle on the road
- 3 Please make sure you have a driving license when driving this vehicle. Do not drive without a license

USER INSTRUCTION

- 4** Do not ride after you take medications which may effect your riding ability, drink alcohol or when you feel physically upset
- 5** Observe traffic regulations and traffic signs, manned and loaded in accordance with local laws and regulations and confirm the surrounding road conditions and bike's conditions at any time, so as to actively avoid danger
- 6** In case of rain and snow, the braking distance shall be increased. Pay attention to slowing down the speed. Try to avoid traveling as much as possible in inclement weather condition
- 7** Wear safety equipment, such as helmet, and appropriate protective clothing if necessary, such as gloves and boots
- 8** In order to ensure the safety of you and others, please DO NOT use high beam in good lighting conditions. The continuous use of high beam will cause the visual disturbance to vehicles and pedestrians on the opposite side, affecting normal driving
- 9** Please pay attention to the safety instruction
 - a.** Electric bikes should not be parked in building foyers, evacuation staircases, walkways and safety exits
 - b.** Electric bicycles should not be charged and parked in residential buildings, and should be far away from combustible materials when charging, and the charging time should not be too long.
 - c.** Please pay attention to the correct use of the battery and warning labels; Waste battery can not be dismantled without authorization, Pls contact the customer service center for the unified recycling treatment
 - d.** Please pay attention to the safe instruction and warning labels of the charger; When replacing the charger, it should match the model of the battery
 - e.** Please pay attention to the precautions concerning water washing
- 10** Check before riding. In case of any abnormality, please timely repair or go to official dealer's service center
 - a.** Check the power circuit, lighting circuit statues etc
 - b.** Check whether the front and rear brakes work properly
 - c.** Check the handlebar and the front and rear wheels fixing
 - d.** Check the tire pressure
 - e.** Check the belt whether loose or damaged
 - f.** Check the belt wheels whether it is damaged
 - g.** Check the belt whether belt wheel tooth groove

QUICK START

- 01 -

Parts inspection



× 2

Quick start



× 1

Mirrors



× 1

User manual



× 2

Keys



× 1

Spanner for mirrors



× 1

Charger

QUICK START

- 02 -

Install battery

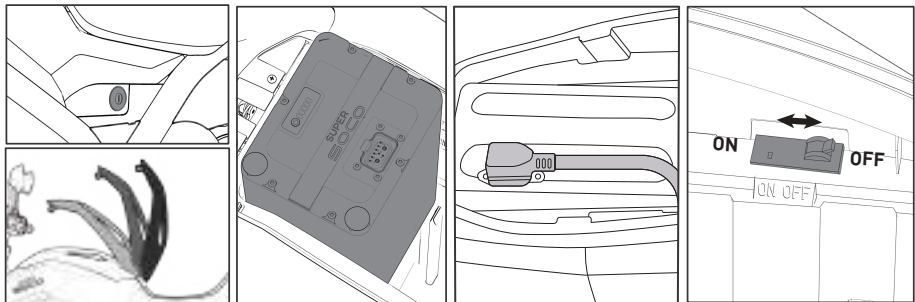

1 Open storage box, take out cover

2 Remove the storage box

3 Connect power plug, make sure it's plugged in and hear a click

4 protector switch, put the storage box in and close

QUICK START

- 03 -

Quick start

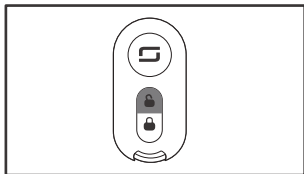

- 1** Press “unlock” on remote control

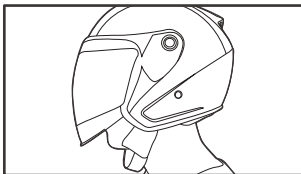

- 2** Put helmet on



- 3** Get on motorcycle, kick side stand out

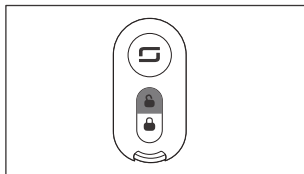

- 1** Press “Power”, power on

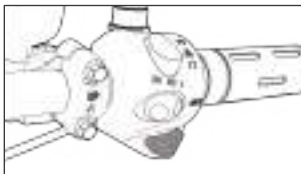

- 5** Press “Parking” button, unparking TC, parking symbol off

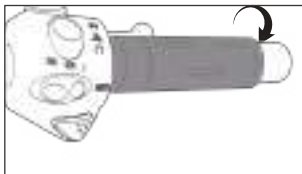

- 6** Turn accelerator gently, motorcycle run

- 04 - Download APP

**TC has GPRS functions, subject to different countries, can connect with your smart phone.
By APP, you can use smart phone to manage and query your TC.**

Only iOS and Android are currently available now, please confirm your smart phone operating system in advance.

iOS system: APP only supports Apple iOS 9.0 system and above.

Android system: APP only supports Android 4.4 system and above.



SOCO APP

From the date of purchase of the vehicle, you will automatically receive a free two-year central control SIM card data in order to use the SOCO electric vehicle APP function. Please be sure to complete the next year's data recharge before the end of the two-year free period. If the recharge is not overdue, the operator will automatically close the recharge interface, the flow recharge function cannot be restored, and the SOCO electric vehicle APP cannot be used normally.

CONTENTS

Accessories checklist	08
Operation guide	11
Ride guide	16
Battery use guide	19
APP instructions	22
Maintenance	23
FAQ	25

DESCRIPTION OF COMPONENTS AND PARTS

a. SCHEMATIC DIAGRAM OF COMPONENTS AND PARTS

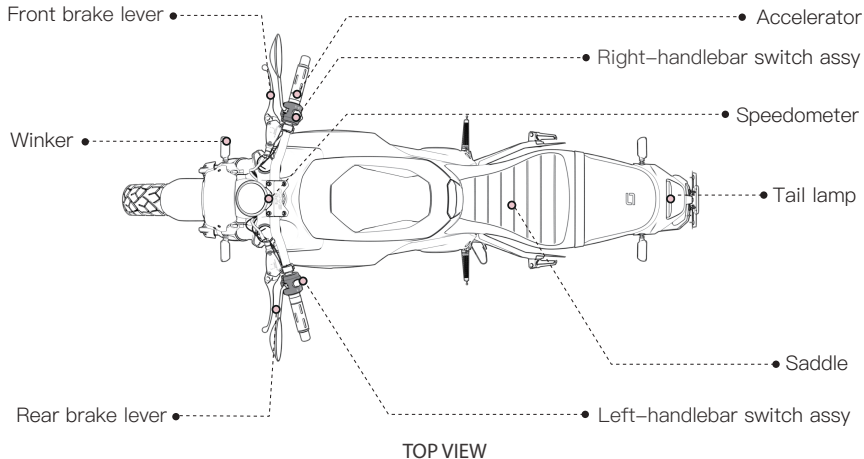

DESCRIPTION OF COMPONENTS AND PARTS

a. SCHEMATIC DIAGRAM OF COMPONENTS AND PARTS

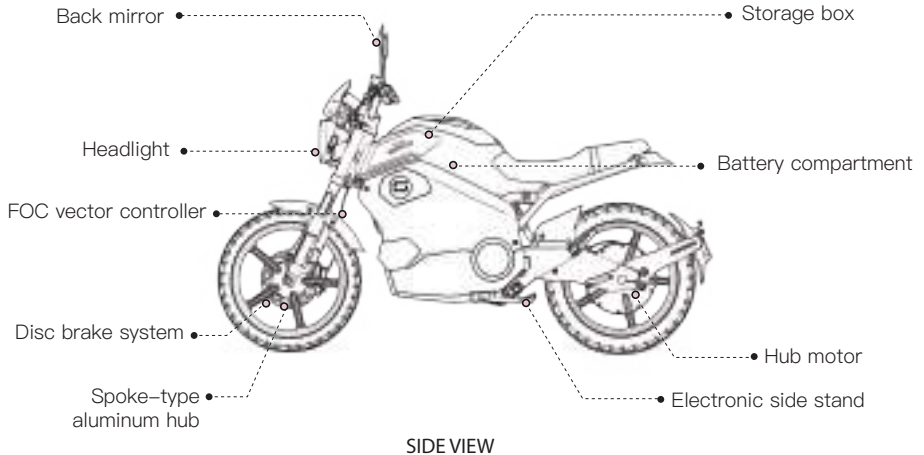

DESCRIPTION OF COMPONENTS AND PARTS

b.SCHEMATIC DIAGRAM OF THE SPEEDOMETER

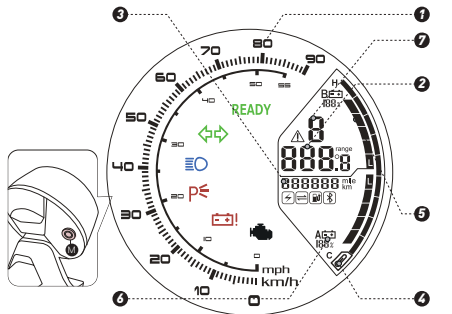

- 1 Speed display
- 2 Cruising range/
Ambient temperature
- 3 Total mileage
- 4 Controller temperature
- 5 Battery indicator
- 6 Battery percentage display
- 7 Gear display

READY Start indicator The vehicle can be started when READY is displayed

OBD Indicating OBD checking error codes
See page 24 FAQ & TROUBLESHOOTING

Charging

Error

High beam indicator

Battery error

Winker indicator

Parking indicator

Indication P shows in parking mode

3 Sport mode

2 Cruise mode

1 ECO mode

BUTTON FUNCTION DESCRIPTION

Display switching—cruising range/ambient temperature In normal mode, short press the key switch to switch strongly and save the state.

Turn on the instrument backlight manually (text version backlight + LCD backlight) In normal mode, press the button to force the instrument backlight and headlights to be turned on

Display unit switching (KM and Mile, km/h and mph) In normal mode, long press the key switch to switch the unit and save the state

TIPS: Short press and press the button for less than 2 seconds, then release the button;

Press the button for less than 8 seconds and longer than 2 seconds, then release the button. Long press the button for more than 8 seconds, then release the button

OPERATION GUIDE

a. Left Switch Assy

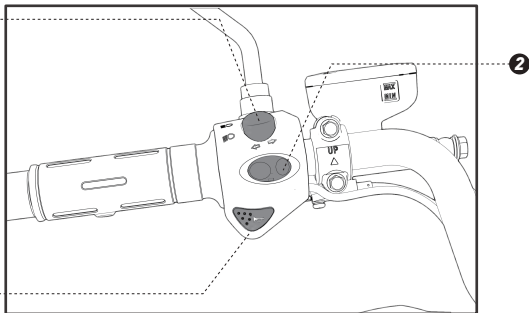
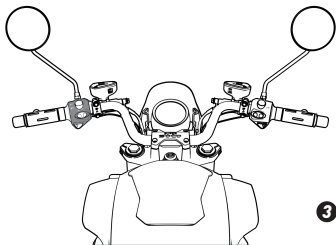

1 High/low beam switch button

Press up to turn on the high beam
Press down to turn on the low beam

2 Winker button

Dial to the left side to turn on the left winker; Dial to the right side to turn on the right winker

3 Horn button

Press to make a sound and release to stop

OPERATION GUIDE

b.Right Switch Assy

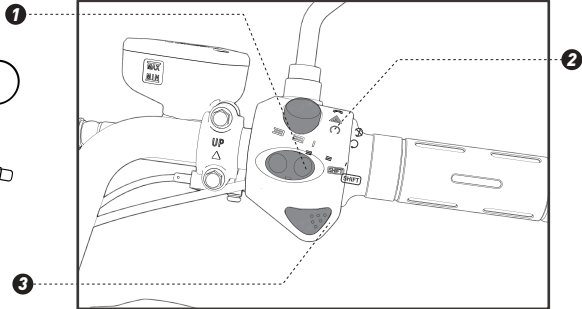
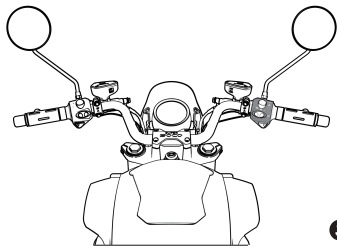

1 Gear shift button

The bike is set with 1 ECO mode, 2 Cruise mode, and 3 Sport mode. To the right is the ECO mode, to the middle is the Cruise mode, and to the left is the Sport mode

2 Emergency flashers

“Emergency flashers” Press the vehicle up to turn on the double flash state, and press it down to turn off the double flash state.

3 Parking button

“Parking button” Press up the vehicle to enter the parking state, the parking indicator (P) will light up; press down the display (READY) to release the parking state.

OPERATION GUIDE

c. Intelligent Remote Control Operation

We use the second generation of SUPER SOCO intelligent remote control key. You can easily lock or unlock the vehicle by tapping the button within the effective distance.

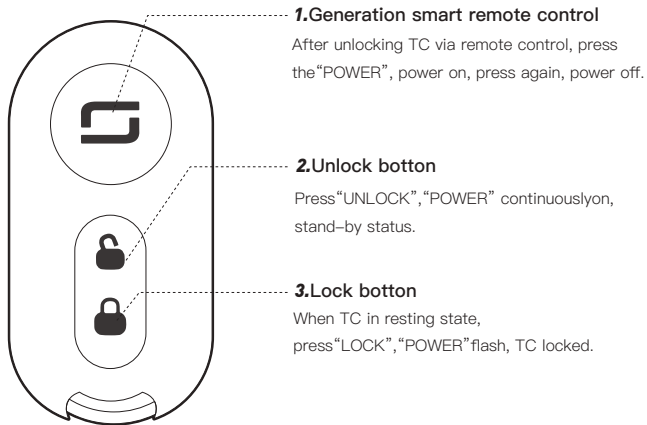

OPERATION GUIDE

d. How To Operate The Physical Handlebar Lock

- ➊ After the bike stops, turn the handlebar to the far left, insert the key into the physical handlebar lock, and rotate it rightwards to lock the bike.
- ➋ Insert the key into the physical handlebar lock, and rotate it leftwards to unlock the bike

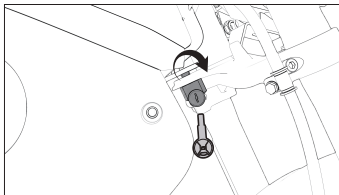
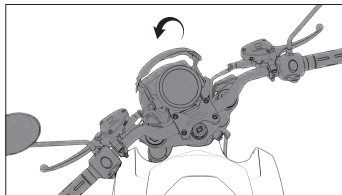

e. Open The Storage box & Cushion

- ➊ Put the key in, turn right, when hear sound “click”, storage open
- ➋ Put the key in, turn left, cushion open

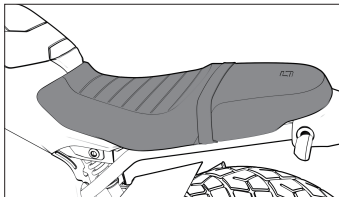
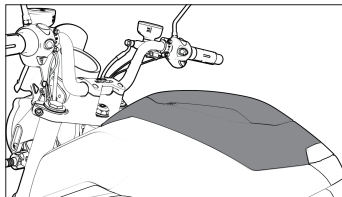

OPERATION GUIDE

f. Circuit Protector Switch Operate

As the protection switch for the main power of electric vehicle, the circuit protector will automatically disconnect to ensure safety when the vehicle circuit is abnormal or the current caused by short circuit exceeds the set safe value.

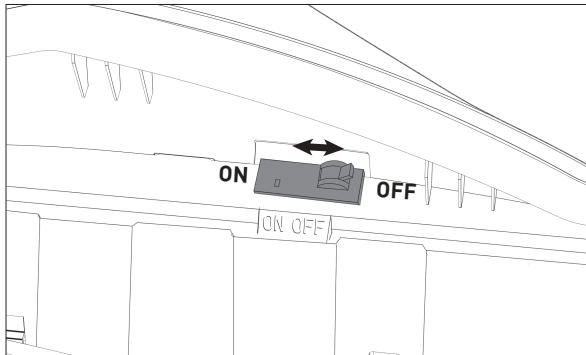

TIPS: In order to protect your safety, please turn off the circuit protector switch when cleaning, storing the vehicle for a long time, or removing the battery .

RIDING GUIDE

a. Check List Before Riding

Make sure to check the following items before riding a TC intelligent electric vehicle, which will guarantee your safety on the road.

- 1 Whether the handlebar is stable and flexible when turning.
- 2 Whether the switches on the right and left handlebars can work correct.
- 3 Whether the throttle working properly.
- 4 Make sure the tyre pressure is ok. The suggested tire pressure is 175Kpa for front wheel, 200Kpa for rear wheel with rider only; 225Kpa for rear wheel with 1 rider and 1 passenger.
- 5 Check tire surface, make sure no cracks, damage, and foreign matter puncture or attachment.
- 6 Whether the tread depth is sufficient.If the tire is worn to the black shadow mark in the picture, it needs to be replaced.
- 7 Whether any error warning light on the display when power on.
- 8 Whether the battery capacity is sufficient for your trip.
- 9 Whether all lights working properly.
- 10 Whether the horn working properly.
- 11 Whether the mirrors are clean. Adjust them to the proper angle.
- 12 Whether the brake oil is sufficient, whether the brake lever and brake

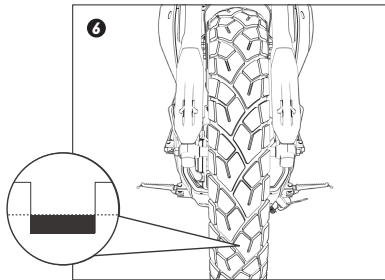

In case any questions or unusual, please contact after sales service or dealer

OPERATION GUIDE

b. Start the vehicle

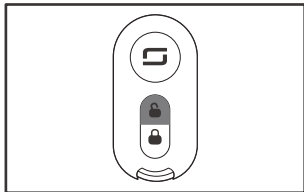

1 Press “unlock” on remote control

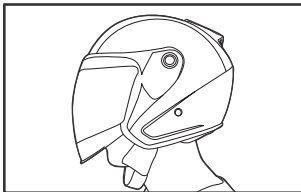

2 Put helmet on



3 Get on motorcycle, kick side stand out

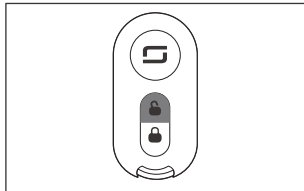

4 Press “Power”, power on

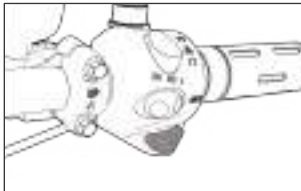

5 Press “Parking” button, unparking TC, parking symbol off

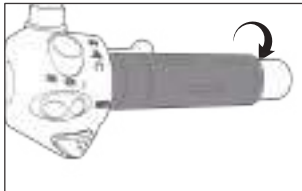

6 Turn accelerator gently, motorcycle run

RIDING GUIDE

TIPS:

- ➊ Before riding, please make sure that the electronic side stand is stowed and turn the handlebar to make sure that the front lock is closed;
- ➋ During riding, if you press the “park button” or turn on the electronic side stand, the whole vehicle will be powered off. Therefore, it is prohibited to press the “park button” or turn on the electronic temple during riding to prevent the vehicle from suddenly losing power in danger
- ➌ The vehicle must be completely stationary to start. If the vehicle is abnormal during travel, please carefully taxi or push to a safe area. Do not try to restart the vehicle during travel or on the lane to avoid danger.

c. Riding precautions

- ➊ When the vehicle starts, it should accelerate slowly to avoid excessive starting current caused by sudden acceleration and increase energy consumption
- ➋ On the premise of ensuring safety, keep a constant speed as much as possible during driving, reduce frequent starting, braking, instant acceleration and other operations to increase energy consumption
- ➌ The maximum load capacity of this vehicle is 150KG, and overloading is strictly prohibited.
- ➍ Please press the “park button” when driving the vehicle to prevent accidental turning of the handlebar, which may cause the vehicle to start suddenly and cause an accident
- ➎ Turn off the power and remove the key when parking

BATTERY USE INSTRUCTION

a. Vehicle Body Charging

- ➊ Insert the main charger plug into the charging port of the vehicle.
- ➋ Insert the charger's AC power plug into the socket, and the battery starts charging when the charger indicator turns red.
- ➌ The battery is fully charged if the charger indicator turns from red to green

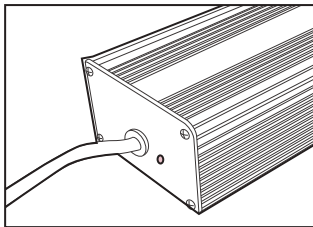
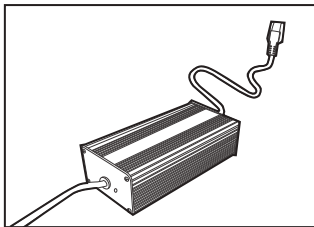

Battery level display

Charging: red light is on continuously

Full: green light on continuously

Fault: red and green light flash alternately

BATTERY USE INSTRUCTION

b. External charging

- 1 Open the storage box, turn off the circuit protector switch and take out the storage box.
- 2 Disconnect the main plug of the battery.
- 3 Insert the main plug of the charger into the charging port of the battery, and then insert the AC power plug of the charger into the socket. When charging normally, the green light of the charger flashes in turn.

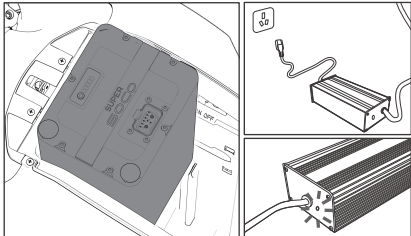
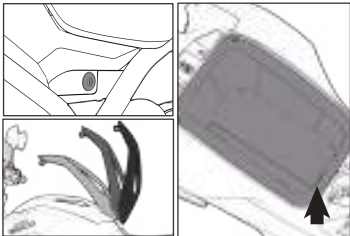

TIPS:

Keep it away from children, fire and heat source;
Charging working temperature: 0–55°C, discharging working temperature:
–20°C–60°C;
The battery pack should be charged as it is used. When not in use for a
long time, be sure to remove it from the vehicle for storage;
Strenuous exercise, impact and squeezing are strictly prohibited;

The designated special charger must be used, and other chargers strictly
prohibited to charge the battery;
The battery and charger have been strictly inspected before leaving factory,
and unauthorized disassembly is strictly prohibited.
Do not expose the battery to water, and prevent it from being damped
by water or rained;
It is strictly forbidden to short-circuit the positive and negative terminals of
the input and output terminals of the battery;

BATTERY USE INSTRUCTION

c. Storage, Maintenance And Transportation

- 1** Please charge the battery to half-saturation state when storing or transporting it (after the battery is discharged, charge it for 3 hours). Disconnect the battery to the vehicle to prevent the battery from over-discharging, place it in a dry and ventilated place, and charge it with a charger for 3.5 hours in two months.
- 2** The battery and charger should be stored in a clean, dry, ventilated place, avoid contact with corrosive substances, and keep away from power, fire and heat sources.
- 3** Battery pack storage conditions: ambient temperature 0–25°C, ambient humidity $\leq 65\%RH$
- 4** To avoid electric shock, please cover the rubber cover of the empty battery plug when using a single battery!

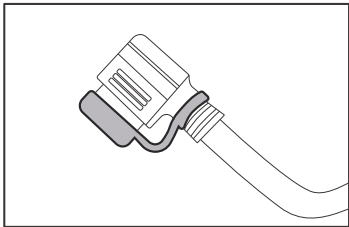

If you encounter any problems, please contact the after sales service or dealer.

APP INSTRUCTIONS

TC intelligent electric vehicle has GPRS communication, GPS positioning and other functions, subject to different countries and can be connected with your smart phone. Through the SOCO Electric Vehicle APP, you can use your smart phone to manage and query your vehicle.

*Some functions require the use of wireless networks and positioning functions, please be aware.

The current mainstream mobile phone system versions are iOS and Android operating systems, please confirm the operating system specifications of the smart phone before installation; Scan the QR code on the right to download and install the SOCO Electric Vehicle APP.

APP supports Apple iOS 9.0 and above

APP supports Android 4.4 and above.

Main functions of SOCO Electric Vehicle APP (Available subject to different countries)

- 1** Vehicle condition diagnosis: when the vehicle is started, a one-key physical examination, real-time understanding of vehicle health status;
- 2** Multiple anti-theft: When the vehicle is illegally displaced, the vehicle body will issue an alarm, and the APP will notify the user as soon as possible and track the vehicle location in real time;
- 3** Data recording: Users can learn about vehicle information, remaining power, mileage, riding trajectory and other information through the APP;
- 4** Riding appointments with riders: Through the APP, users can start mobile social interaction, realize communication between people in a new way, and enjoy the fun of online and offline riding

The functions of soco Electric Vehicle APP may vary with version updates, function upgrades and different vehicle types. Please refer to the actual content of the latest version.

MAINTENANCE

Regular maintenance can improve the service life and driving safety of TC intelligent electric vehicle. We suggest you follow the following advice to take care of your vehicle.

a. Regular Inspection And Maintenance

We recommend that after the initial inspection and maintenance of the new vehicle at the Super Soco Authorized Service Center, 1000 km or 2 months after the purchase of the new vehicle (based on the first arrival parameter). It is recommend that you do it every 3000KM or 6 months (based on the first arrival parameter) for regular inspection and maintenance. Super Soco Authorized Service Center will provide maintenance services for your vehicle (maintenance services may involve fees, please refer to the service center staff or official customer service staff).

TIPS:

The maintenance provided by Super Soco Authorized Service Center is free of charge, which can be did by yourself or at a regular electric vehicle repair shop

b. Daily Cleaning And Maintenance

- Cleaning: Please use clean water, neutral detergent, soft cloth and sponge to clean the surface of the vehicle; Do not use metal brush, sandpaper, etc. to wipe the body, so as not to scratch the body and parts. On the surface. After cleaning, wipe the vehicle dry with a soft dry cloth.
- Storage: Please park the vehicle in a dry and cool room to reduce sun exposure and rain, in order to avoid corrosion of parts and shorten the service life.

MAINTENANCE

c. Warning

- ❶** Please switch off the circuit protector switch before cleaning.
- ❷** Do not use strong pressure water to wash it directly, in order to prevent internal electrical components and lines from intruding or soaking water and causing vehicle mechanical failures or other hidden dangers of accidents.
- ❸** In case don't use for long time, please turn off circuit protector switch and disconnect the battery from vehicle; prevent over discharging, please recharge the battery once a month
- ❹** After long-term storage, please fully charge it before use.

FAQ& TROUBLESHOOTING

a. FAQ & Troubleshooting

Error	Causes	Solutions
The vehicle has no electricity, and the start button does not shine	<ol style="list-style-type: none">1. Battery is poorly connected2. Circuit protector switch is not turned on	<ol style="list-style-type: none">1. Connect the power cable appropriately2. Turn on the circuit protector switch
Power on, turning accelerator, motor not run	<ol style="list-style-type: none">1. Low battery power2. Slide stand is on3. At parking mode4. Brake lever does not reach the right position5. Accelerator error6. The controller plug is loose7. Controller error	<ol style="list-style-type: none">1. Charge the battery2. Kick the side stand out3. Press parking button4. Place the brake lever at the right position5. Change accelerator6. Re-plug controller7. Change controller
Speed is too slow or mileage is too short	<ol style="list-style-type: none">1. Low battery power2. Flat Tyre3. Heavily overloaded4. Brake pads need to be replaced5. Battery aging or normal scrap	<ol style="list-style-type: none">1. Charge the battery2. Pump up the tire, check tire pressure before riding.3. Foster a good habit, keep an appropriate load4. Change the brake pads and check the brake system before riding5. Change battery
Battery cannot be charged	<ol style="list-style-type: none">1. Poor contact of charger plug2. Used wrong charger3. Battery aging or normal scrap	<ol style="list-style-type: none">1. Check whether the battery plug is at right position or not2. Use SUPER SOCO charger3. Change the battery

FAQ& TROUBLESHOOTING

Error	Causes	Solutions
Error 99 on speedometer	Controller communication error	Please contact after sales service or dealer
Error 98 on speedometer	Controller stop working(Possible over current,motor blocking,under voltage, over temperature)	Please stop riding and wait for a while then restart or contact after sales service or dealer
Error 97 on speedometer	Controller power tube error	Please contact after sales service or dealer
Error 96 on speedometer	Controller hall sensor error	Please contact after–sales service or dealer
Error 95 on speedometer	Accelerator error	Please check the accelerator plug or contact after sales service or dealer
Error 94 on speedometer	Battery communication error	Please check the battery plug or contact after sales service or dealer
Error 93 on speedometer	Charging, over current error	Please stop charging and check the charger
Error 92 on speedometer	Charging, over voltage error	Please stop charging and check the charger
Error 91 on speedometer	Battery over temperature error	Please stop riding or charging and wait for a while

FAQ& TROUBLESHOOTING

Error	Causes	Solutions
Error 90 on speedometer	Battery discharging over current error	Please stop riding if keep showing and contact after sales service or dealer
Error 89 on speedometer	Battery charging low temperature error	Please move the bike to warm indoor place and wait for a while
Error 88 on speedometer	Battery discharging low temperature	Please move the bike to warm indoor place and wait for a while
Error 87 on speedometer	Network connection error	Please move the vehicle to open area and wait for a while or contact after sales service or dealer
Error 86 on speedometer	GPS connection error	Please move the vehicle to open area and wait for a while or contact after sales service or dealer

FAQ& TROUBLESHOOTING

c. BATTERY FAULT REMOVAL

Battery Status	Issues	Causes	Solution
Before using	Battery runs out, unable to activate the vehicle	Battery no power	Please charge the battery
In Operation	In battery low power mode. Battery below 10% ,vehicle power-off	Battery runs out, low-voltage protection	Please charge the battery
In Operation	Display 88 Error code	Battery discharging low temperature	Please move the bike to warm indoor place and wait for a while
In Operation	Display 90 error code	Battery discharging over current error	Please stop riding if keep showing and contact after sales service or dealer
In operation	Display 91 error code	Battery over temperature error	Please stop riding or charging and wait for a while
In Operation	Display 94 error code	Battery communication error	Please check the battery plug or contact after sales service or dealer
In Operation	Display power reduce, over night or the next day.	ECU, controller and alarm components take power from battery automatically, normal phenomena.	Normal use
In Operation	Mileage different from the official announced	Official announced mileage is tested under specific circumstances and states. Affected by different road condition, weather, temperature, wind resistance, loading etc.	Any questions, please contact after sales service or dealer

FAQ& TROUBLESHOOTING

Battery Status Issues		Causes	Solution
Storage	Press “Start” , no power	The battery is stored too long time, battery runs out	Please charge the battery. If it is not possible to charge, please contact after sales service or dealer
In Charge	Display 89 error code	Charging at low temperature	Please charge the battery in room temperature.
In Charge	Display 92 error code	Charging over voltage	Stop charging the battery, check the charger
In Charge	The charger gets hot during charging	In the charging process, the internal current of the charger is too high, produce large amount of heat. The metal shell can effectively dissipate heat, which will lead to the high temperature of the shell	Please use normally, charge in dry and ventilated place
Battery water penetration	The battery is not working properly, unable to start the vehicle.	Vehicle in the rain, in the water, wading across deep causing battery flood.	Please stop using, contact after sales service or dealer
Battery box broken	Battery shell broken caused by clash or drop from high place.	Battery shell broken	Please stop using, contact after sales service or dealer



SOCO APP

Download APP



Bind APP

PASTE
BARCODE

Only iOS and Android are currently available now, please confirm your smart phone operating system in advance.

iOS system: APP only supports Apple iOS 9.0 system and above.

Android system: APP only supports Android 4.4 system and above.

CHECK LIST	1000KM 3months	3000KM 6months	6000KM 12months	9000KM 18months	12000KM 24months	15000KM 30months	18000KM 36months	21000KM 42months	24000KM 48months	Torque (N-m)
Brake fluid	<input type="radio"/>		<input type="radio"/>							
Tire pressure and wear	<input type="radio"/>	<input type="radio"/>	<input type="radio"/>	<input type="radio"/>		<input type="radio"/>		<input type="radio"/>		"FR 175 KPa RR 225 KPa"
Front and rear lining pad wear		<input type="radio"/>	<input type="radio"/>	<input type="radio"/>		<input type="radio"/>		<input type="radio"/>		
Front and rear brake disc wear			<input type="radio"/>							
Fasten front axle nut and rear wheel bolt	<input type="radio"/>		<input type="radio"/>							59
Fasten the swingarm nut	<input type="radio"/>		<input type="radio"/>							59
The motor and the motor retainer bolt fastening nut	<input type="radio"/>		<input type="radio"/>							80
Fasten Front and rear shock bolt fastening	<input type="radio"/>		<input type="radio"/>		<input checked="" type="radio"/>		<input checked="" type="radio"/>		<input checked="" type="radio"/>	F.Upper 22/ F.Lower 32/R45
Steering column locking nut										74
Fasten front caliper bracket (coated glue thread)	<input type="radio"/>		<input type="radio"/>							26
Fasten front brake disc (coated glue thread)	<input type="radio"/>		<input type="radio"/>							42
Fasten rear caliper bracket (coated glue thread)	<input type="radio"/>		<input type="radio"/>							26
Fasten rear brake disc (coated glue thread)	<input type="radio"/>		<input type="radio"/>							42
Battery	<input type="radio"/>	<input type="radio"/>	<input type="radio"/>	<input type="radio"/>		<input type="radio"/>		<input type="radio"/>		

Note: Check the lithium battery balance by BMS reading and manual measurement.

MAINTENANCE RECORD:
CONTENT:

DATE:

MAINTENANCE RECORD:
CONTENT:

DATE:

MAINTENANCE RECORD:

CONTENT:

DATE:

MAINTENANCE RECORD:

CONTENT:

DATE:

**MAINTENANCE RECORD:
CONTENT:**

DATE:

**MAINTENANCE RECORD:
CONTENT:**

DATE:

MAINTENANCE RECORD:

CONTENT:

DATE:

MAINTENANCE RECORD:

CONTENT:

DATE:

**MAINTENANCE RECORD:
CONTENT:**

DATE:

**MAINTENANCE RECORD:
CONTENT:**

DATE: